



DuraJet G5

Proven in harsh environments since 5 generations

1-250 kg

Rockwell

Super Rockwell

Plastic testing

Carbon testing

HBD, HVD

EMCO·TEST

The robust multi-talent.

Precision, flexibility and safety.



Universal application thanks to a wide load range and a variety of possible test methods.

The electronically controlled load application and the load range of 9.8 N to 2450 N (1 kgf to 250 kgf) fully covers the entire Rockwell range by a single device. In addition, plastic tests, carbon tests as well as Vickers and Brinell tests in-depth can be performed. This flexibility, combined with ease of operation, makes DuraJet G5 the device of choice where previously multiple devices were used in various configurations.



Rockwell

according to EN ISO 6508, ASTM E-18

HRA	HRL	HR 15-T	HR 15-Y
HRB	HRM	HR 30-T	HR 30-Y
HRC	HRP	HR 45-T	HR 45-Y
HRD	HRR	HR 15-W	HRX
HRE	HRS	HR 30-W	HRY
HRF	HRV	HR 45-W	HRZ
HRG	HR 15-N	HR 15-X	HR 2/10
HRH	HR 30-N	HR 30-X	HR 2/20
HRK	HR 45-N	HR 45-X	HR2/120



Plastic testing

according to EN ISO 2039

49.03 N	132.9 N	357.9 N	961 N
---------	---------	---------	-------



HVD, HBD

depth measurement (non-standard)

HVD 5 to HVD 100
HBD 1/5 to 2,5/187,5, HBD 5/250



Carbon testing

according to DIN 51917

2.5/7	5/7	5/15	5/20
5/40	5/60	5/100	5/150
10/20	10/40	10/60	10/100
10/150			

The DuraJet G5.

Overview of important functions.

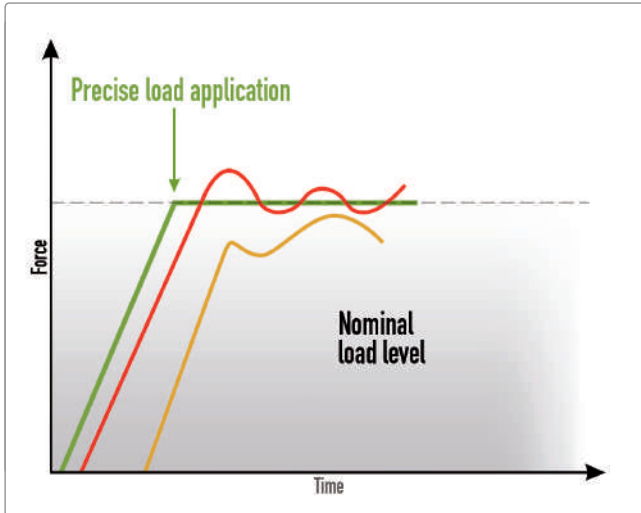

G5 - electronic load application already in the 5th generation.

The principle of electronically controlled and permanently monitored load application offers significant advantages and was patented by EM-CO-TEST in 1992. The force is precisely applied and continuously monitored; this prevents overshooting when placing the indenter and ensures the greatest possible resistance against vibration. The entire test cycle is controlled electronically and thus ensures high repeatability, independent of the operator. Furthermore, compliance with the periods for pre- and main load that are strictly specified in the series of standards ASTM and EN ISO is guaranteed, which is not the case if the tests are manually performed. The DuraJet G5 uses the latest generation of PLC-based controllers. The modular design and the robustness of the components ensure high machine availability, ease of service and long availability of spare parts.

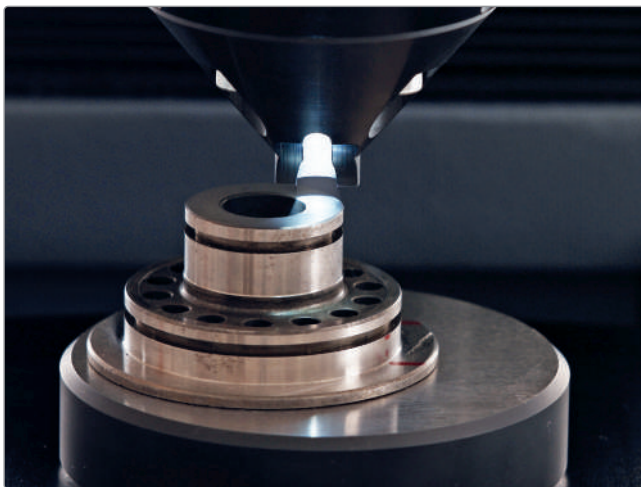

Working space lighting

A LED integrated into the nose cone illuminates the working space around the measuring point, which allows the precise placement of test points even in difficult lighting conditions. The LED is absolutely glare-free and can be continuously dimmed.

Fully automatic test cycles

The measurement starts automatically after clamping the work piece. The release is automatically triggered once the measurement is complete and the path can be adjusted. This is a tremendous time saver in series tests and facilitates the handling of heavy components in conjunction with the optional foot switch.



ecos Workflow DuraJet Edition

The proven and intuitive workflow principle guides the user step by step through all necessary settings such as test methods, conversions, geometric corrections, etc. up to data storage and reporting. This saves time and reduces operation errors. The entire machine control and the operating software **ecos Workflow DuraJet Edition** are implemented in a robust and industrial-grade PLC (electronic control unit). The fact that no PC components are used increases reliability, especially in harsh production environments.

Proven technology with a modern look.

Highlights in detail.

Nose cone with integrated working space lighting

The work piece is clamped with the high-precision nose cone. It can be replaced individually or removed for measurements without clamping. The integrated LED lighting provides good visibility of the test specimen, even in difficult lighting conditions. The test unit can be moved vertically by pressing a button (0–260 mm).

Test anvil with device adapter

The solid test anvil features four M6 mounting points for larger accessories such as cross-slides in addition to a 25 mm fit bore for the centred mounting of standard accessories such as various prisms and plane tables. This also allows for the simple fixing of customer specific devices without handling the hardness tester.

Interfaces

The control panel has two USB ports (one on the front) for data backup on USB sticks, for printing reports or for connecting a bar code scanner. RJ45 allows for the connection of the DuraJet to a network. Test data and reports can therefore be saved on a network drive.

7" touch display

Despite its high functionality, the operating software "ecos Workflow DuraJet Edition" offers the familiar intuitive EMCO-TEST operation.



USB interface

Start test

Height adjustment of nose cone



Highest safety standards

In addition to CE conformity, which is a matter of course to us as an European manufacturer, DuraJet also complies with the highest international standards. DuraJet furthermore meets North American safety requirements because of the use of high quality components and materials. (Control modules are "UL Listed" and plastic covers have the highest fire resistance class).

PLC (programmable logic controller)

The exclusive use of standard PLC modules for the control of the hardness tester ensures high reliability and ease of maintenance. This also guarantees the long-term availability of quality spare parts.

Hardware interface (optional)

This optional interface allows the clamping and testing process to be controlled by an external system controller or the optional foot switch. This interface provides for the simple integration of the hardness tester in unmanned automation solution operations.

The new benchmark for Rockwell testers. ecos Workflow DuraJet Edition.



Capacitive touch screen

The capacitive touch display provides for the clear representation of test parameters and can be used with most gloves. Robust and ergonomic buttons for the most important functions are additionally integrated in the control unit to facilitate the operation in harsh working environments.



Auto start on touching the work piece

Only a single button is needed to clamp and test the work piece. The measurement starts immediately after clamping of the work piece; it is released immediately after the measurement (by the preset degree). This is especially important in serial testing as it results in huge time savings.

Fast Mode provides faster test cycles

This function shortens the time of load application and release by about 6 seconds. The holding times can be additionally set to a minimum of 0.1 seconds, thereby enabling extremely fast test sequences. Measurements using this function are no longer standard compliant.

Familiar and easy operation.

Results in 3 steps.

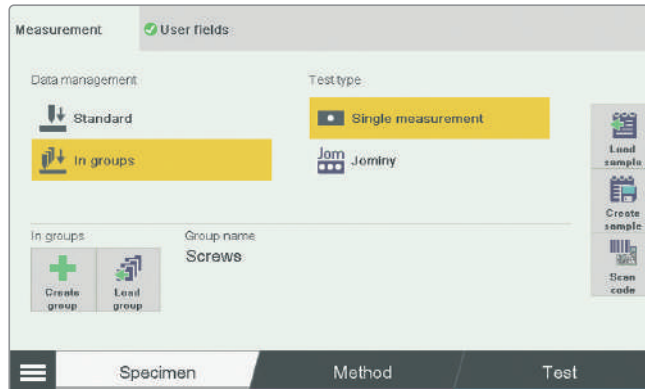

1. Specimen

Select the test type or load existing templates (settings) from a list or via a linked code with a connected bar code/QR code scanner.

The DuraJet G5 additionally allows for the archiving of structured test data. Already at this point, data groups can be created or loaded which are then used to store all test data. This is in addition to the standard test data management, which saves all test results in a collection list.

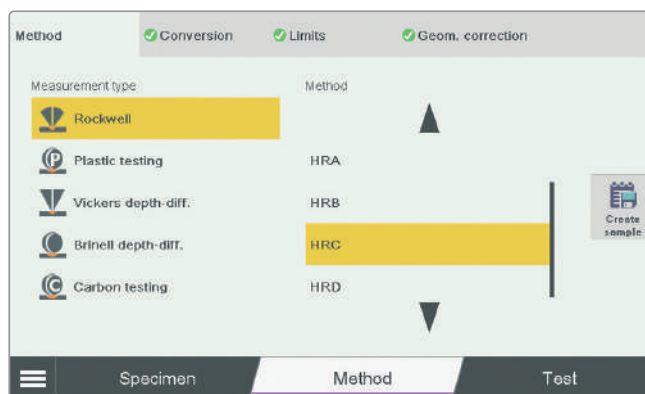

2. Method

Select test methods, conversions, geometric corrections, and limits. All settings can be saved as a template. The test data management used is also stored in the template. This provides for the easiest assignment of tests to components, lots, production lines or operators.

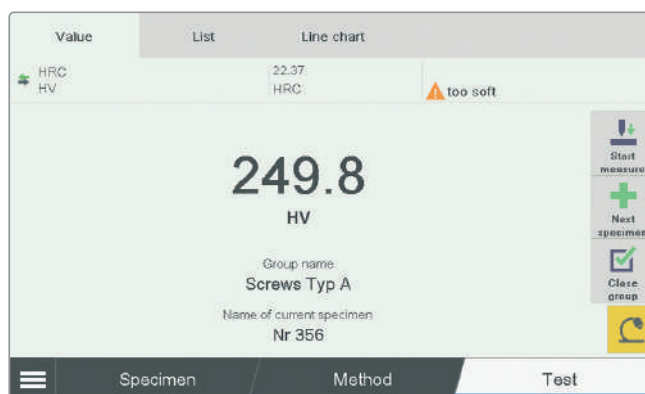

3. Test

Perform the measurement. Adjust the working space lighting according to your requirements. This is where test results, conversions, the current measurement data grouping or limit value violations are displayed. All tests with the selected data groups can be displayed as lists at any time.

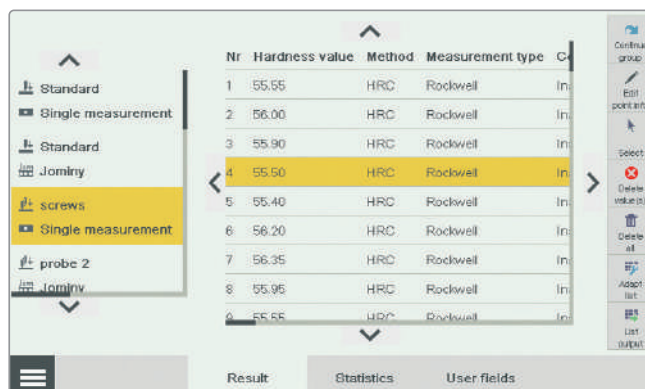

Archive

The archive collects all measurement data groups and all measurements. Statistical values can be displayed from each measurement data group and the measured values can be exported, saved or printed as a report.

Other highlights.

Data management.



Data management

A measurement data group can be created or selected already prior to a test. All test results are then collected in separate lists, which can be clearly displayed, exported or saved as a report at any time.

Use measurement data groups to assign test data to individual operators or groups of users, components, batches or departments.

All tests performed with the default setting will obviously also be collected in a standard list. Nothing gets lost.



Template function

Easily and efficiently create templates of frequently used test parameters. This function considerably reduces operator time and the possibility of operation errors. Selecting the template automatically sets all relevant settings (method, measurement data group, conversion, geometric correction, etc.).

Any QR or bar code can also be assigned to each stored template. This code can be read by a connected scanner. The assigned template will be loaded automatically and the test can be started immediately. Existing identification codes on components or docketts can be used to speed up the testing process and to avoid user errors.

Transparent data availability.

All test information is clearly documented.



Efficient data management

The large number of measurements collected in the context of a comprehensive quality assurance requires very high precision and availability in the computerized QA systems. Therefore, a complete documentation and the secure assignment of measurement data to a respective work piece is particularly important. The export function integrated in the ecos Workflow software provides the required interface. The risk of data errors during logging is eliminated.

Test reports

Test reports can be created in A4 format and output to a directly connected printer. These reports can also be saved as PDF file on USB storage devices or network drives.

Data export

All test data can be output directly via the serial interface (USB RS232 adapter). The data saved in .csv format via USB or via RJ45 directly on a network drive can be further processed with a wide variety of applications (e.g.: spreadsheet programs).

Ready for all requirements.

An excerpt from the extensive range of accessories.

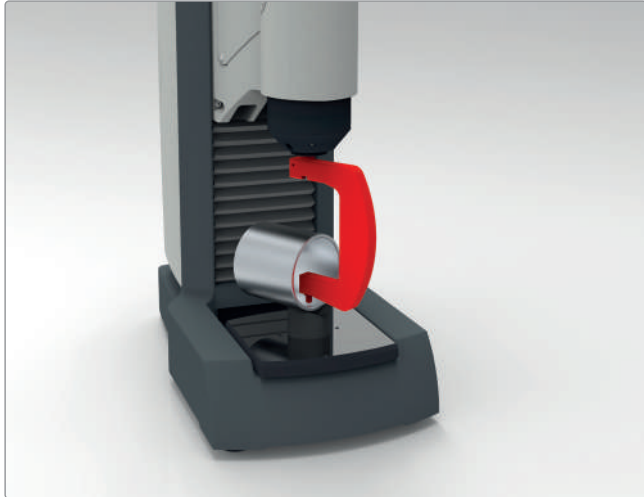

C-Adapter shown in red

C-Adapter

The C-Adapter can access even difficult-to-reach test points. The test is always performed without clamping, i.e. the specimen must be fixed. Retooling is quick and easy (test height is reduced by 170 mm).

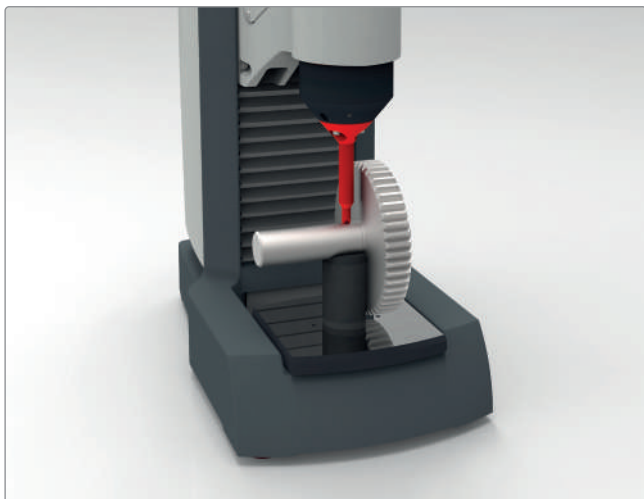
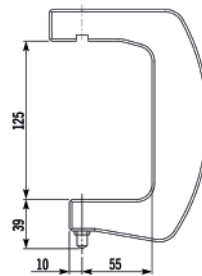

Nose cone extension shown in red

Nose cone extension

The nose cone extension improves the access to difficult-to-reach test positions. Various test anvils are available for stressed tests in grooves, close to offsets or even on crankshafts (working space lighting is not possible, test height is reduced by 86 mm)

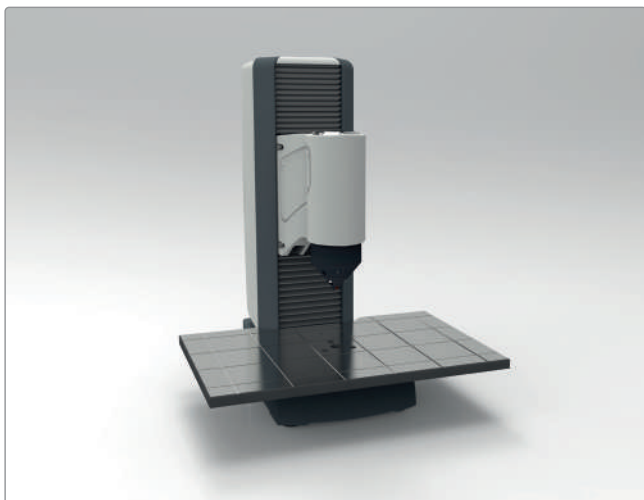
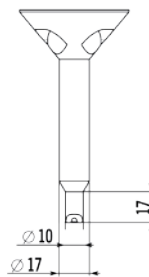

Large test anvil

The DuraJet can also be ordered with a large test anvil for large and bulky specimens. It offers the same interface for accessories as the standard test anvil (1x $\varnothing 25$ mm, 4x M6) in addition to the large surface of 600 x 390 mm. The maximum test height with the large test anvil is 240 mm.

External machine control via hardware interface

This additional interface allows for the integration of the DuraJet in an automated system and therefore 100% inspections without removing single test pieces from the production process. Another possibility is to connect the optional foot switch.

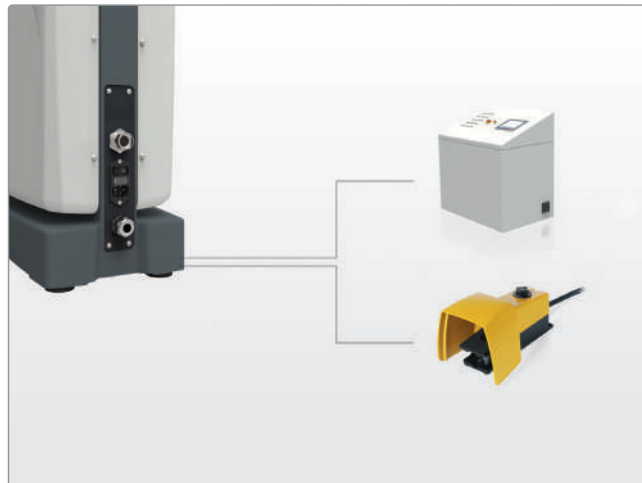

Foot switch

The foot switch can be used to control the clamping process and thus the fixing of bulky specimen. The DuraJet G5 function “Auto start after clamping” can be optionally used to perform the entire test cycle without manual control. The foot switch is supplied with a 2.5 m long cable and an emergency stop function, which is triggered when pressing completely downwards. The foot switch must be equipped with a hardware interface (see above) to connect it to the DuraJet G5.



More accessories

All accessories for the hardness tester DuraJet G5 are available on www.emcotest.com, including: various indenters (also certified according to the international standards EN ISO or ASTM), special nose cones, plane and V-tables, data cables, test blocks and many more.

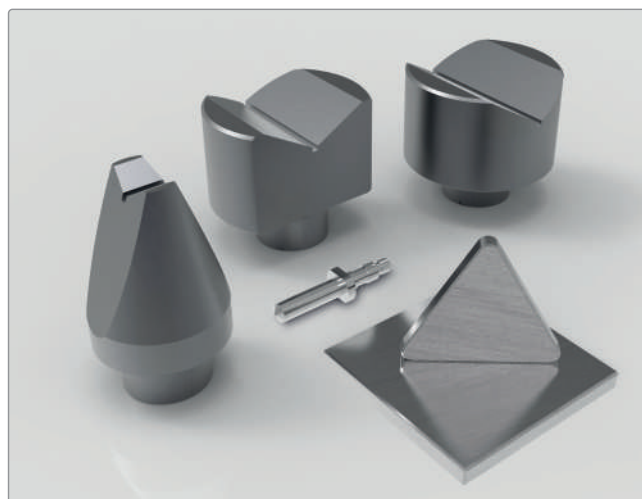

LOOKING BACK ON OVER 65 YEARS OF COMPETENCE.

Competence and experience – hand-in-hand.

Our success is founded on the vision of Karl Maier to build hardness testing machines that «do everything simply, rather than simply everything». In the form of simple testing tools that implement the most complicated functions. This is why Salzburg businessman and mechanical engineer Maier decides to establish a hardness testing department in his company, Maier & Co Maschinenfabrik (later EMCO Maier GmbH), in 1954.

When Karl Maier dies in 1978, his innovative testing products have long since made a name for themselves. The founder's son, Ernst Alexander Maier, takes over the company, which under his leadership becomes a technological leader in the field of hardness testing, not only in Austria, but far beyond its borders. 1989 marks a milestone with invention of a closed-loop control system for load application in hardness testers. For the first time worldwide, it enables testing with all test methods and many load levels in a single universal hardness testing machine. Patent applications are submitted for this revolutionary invention not only in Europe, but also in

the USA and Japan, and it still represents the technological basis for all modern hardness testers. In 1996, the hardness testing department becomes a separate company and EMCO-TEST Prüfmaschinen GmbH is founded.

The death of Ernst Alexander Maier in the year 2001 is a grievous loss, because his extraordinarily visionary spirit has not only shaped the development of the company, but also its employees and milieu. His humanity and sense of responsibility with respect to the region and the environment are also sorely missed. The figures for themselves: Approximately 50 employees at the company headquarters in Kuchl subsidiary are responsible for our international commercial success. We are currently active in 44 countries – each in collaboration with exclusive distribution partners. Together with our motivated and talented team, we have turned Karl Maier's vision into a living reality – his idea has become our mission. Or to put it another way: «We don't make simply everything for hardness testing, but we do make everything in hardness testing simple.»



Premium quality with certified quality promise (ISO 9001)

In order to ensure that only perfect quality is supplied to you, every EMCO-TEST testing machine is thoroughly and stringently tested before delivery. The ease of service is taken into consideration right from the beginning in the design phase. The results are menu-driven fault detection, integrated self-diagnosis and modular exchange of electronic components that ensure the remedying of faults in a minimum of time. Software updates that take into consideration changes in standards or optimise future processes ensure high investment security for you.

10 years spare parts availability

For EMCO-TEST hardness testing machines we guarantee spare parts availability of least 10 years after a product has been discontinued. To secure your investment in a EMCO-TEST testing machine, we extend this availability by several more years whenever possible, significantly exceeding standard industry requirements.



Everywhere suitable.

Optimal features for all fields of application.

Latest technology ...

- Precise load application with a wide load range
- Wide range of test methods
- Automatic test cycle (ensures standard compliance)
- Intuitive user guidance by a workflow based operating software
- Capacitive 7" touch screen
- Network compatible

... in a sturdy package

- Machine base and test unit made of cast iron
- Sealed bearings and guides
- Screws and surfaces protected against corrosion
- Reliable drive components made in Europe
- Machine control exclusively by industry proven electronic modules (PLC)



Technical data.

All key facts at a glance.

Overview of functions	Standard	Option
7" capacitive colour display (can be operated with gloves)	•	
Load range 9.8–2450 N (1 kgf–250 kgf) – electronically controlled	•	
Machine control with integrated PLC	•	
Motor-driven height control of test unit (6 mm/sec.)	•	
Working space lighting (integrated in nose cone, dimmable)	•	
Template function	•	
Network interface RJ45	•	
Export data via serial port (USB-RS232 adapter required)	•	
USB interface	2 x	
Test report in PDF format	•	
Fast Mode	•	
Test data management	•	
Rockwell, Rockwell Superficial (EN ISO 6508, ASTM E-18)	•	
Plastic testing (EN ISO 2039)	•	
Carbon testing (DIN 51917)	•	
HVD, HBD (not standardised)	•	
Testing clamped/unclamped	•	
Large test anvil 600 x 390 mm		•
Jominy module		•
Hardware interface (for activation by foot switch or system controller)		•

Functional dimensions:

Nose cone support diameter (standard)	Ø 15 mm
Nose cone bore (standard)	Ø 8 mm
Test anvil support	Ø 25
Max. test height	260 mm
Throat depth	175 mm
Maximum workpiece weight	100 kg
Resolution of load measurement	24 bit
Resolution of depth measurement	0,02 µm

Machine data:

Weight of basic unit	110 kg
Dimensions (W x H x D)	300 x 740 x 565 (mm)
Protection class to EN 60529	IP20
Power consumption (max./standby)	120 W/35 W
Main fuse (110/230V)	T6.3A
Ambient temperature	5–40°C
Humidity	max. 90% (non-condensing)

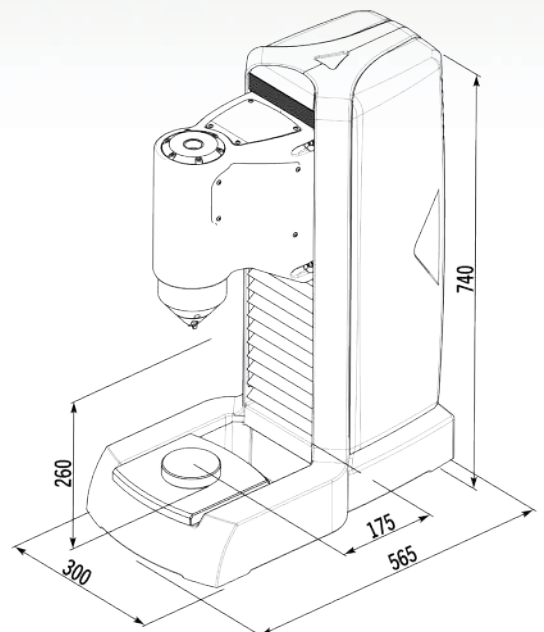

Benefit from our global sales and service network!



More on emcotest.com

EMCO-TEST

EMCO-TEST Prüfmaschinen GmbH

Kellau 174

5431 Kuchl-Salzburg/Austria

office@emcotest.com

www.emcotest.com

Tel. +43 6244 204 38

Fax +43 6244 204 38-8

